

SURFACE MOUNT GLASS PASSIVATED
HIGH EFFICIENCY SILICON RECTIFIER
VOLTAGE RANGE 50 to 600 Volts CURRENT 1.0 Ampere

FEATURES

- * Fast switching
- * Glass passivated device
- * Ideal for surface mounted applications
- * Low leakage current
- * Metallurgically bonded construction
- * Mounting position: Any
- * Weight: 0.015 gram

MECHANICAL DATA

- * Epoxy : Device has UL flammability classification 94V-0

MAXIMUM RATINGS AND ELECTRICAL CHARACTERISTICS

Ratings at 25 °C ambient temperature unless otherwise specified.
 Single phase, half wave, 60 Hz, resistive or inductive load.
 For capacitive load, derate current by 20%.

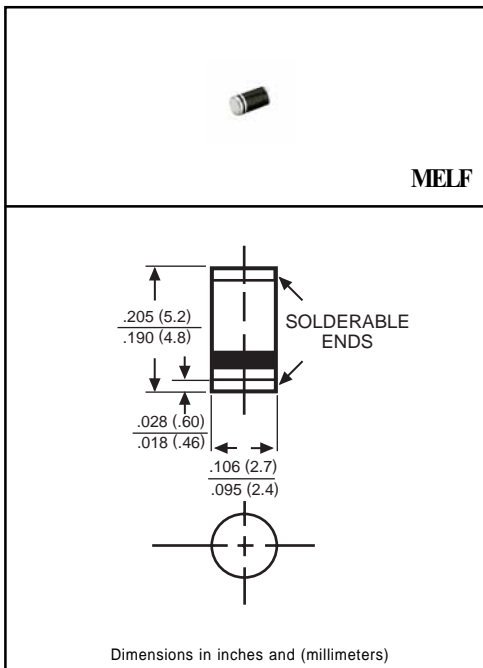

MAXIMUM RATINGS (At TA = 25°C unless otherwise noted)

RATINGS	SYMBOL	HSM101	HSM102	HSM103	HSM104	HSM105	HSM106	UNITS
Maximum Recurrent Peak Reverse Voltage	VRRM	50	100	200	300	400	600	Volts
Maximum RMS Volts	VRMS	35	70	140	210	280	420	Volts
Maximum DC Blocking Voltage	Vdc	50	100	200	300	400	600	Volts
Maximum Average Forward Current at TA = 50°C	Io	1.0						Amps
Peak Forward Surge Current 8.3 ms single half sine-wave superimposed on rated load (JEDEC method)	IFSM	30						Amps
Typical Junction Capacitance (Note 2)	CJ	15				12		pF
Operating and Storage Temperature Range	TJ, TSTG	-65 to + 175						°C

ELECTRICAL CHARACTERISTICS (At TA = 25°C unless otherwise noted)

CHARACTERISTICS	SYMBOL	HSM101	HSM102	HSM103	HSM104	HSM105	HSM106	UNITS
Maximum Instantaneous Forward Voltage at 1.0A DC	VF	1.0			1.3		1.70	Volts
Maximum DC Reverse Current at Rated DC Blocking Voltage TA = 25°C	IR	5.0						uAmps
Maximum Full Load Reverse Current Average, Full Cycle .375" (9.5mm) lead length at TL = 55°C		100						uAmps
Maximum Reverse Recovery Time (Note 1)	trr	50				75		nSec

NOTES : 1. Test Conditions: IF=0.5A, IR=-1.0A, IRR=-0.25A.
 2. Measured at 1 MHz and applied reverse voltage of 4.0 volts.

RATING AND CHARACTERISTIC CURVES (HSM101 THRU HSM106)

FIG. 1 - TEST CIRCUIT DIAGRAM AND REVERSE RECOVERY TIME CHARACTERISTIC

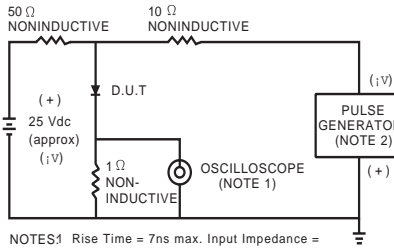

NOTES: 1. Rise Time = 7ns max. Input Impedance = 1 megohm, 22pF.
2. Rise Time = 10ns max. Source Impedance = 50 ohms.

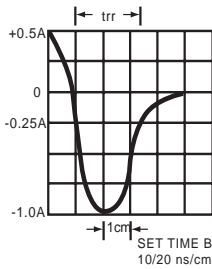

FIG. 2 - TYPICAL FORWARD CURRENT DERATING CURVE

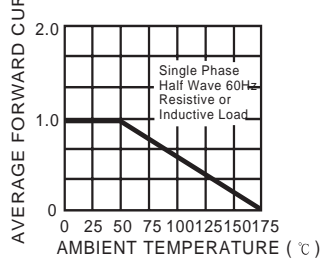

FIG. 3 - TYPICAL REVERSE CHARACTERISTICS

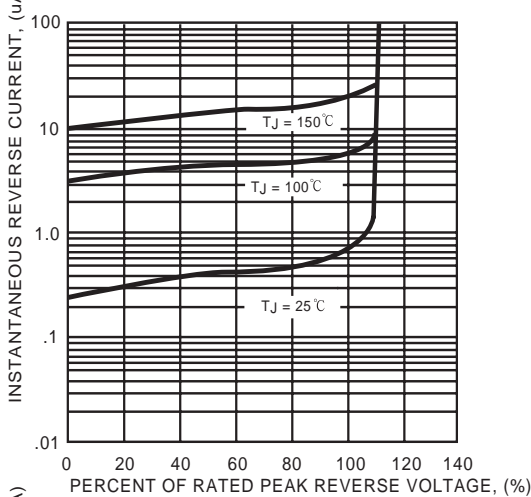

FIG. 4 - TYPICAL INSTANTANEOUS FORWARD CHARACTERISTICS

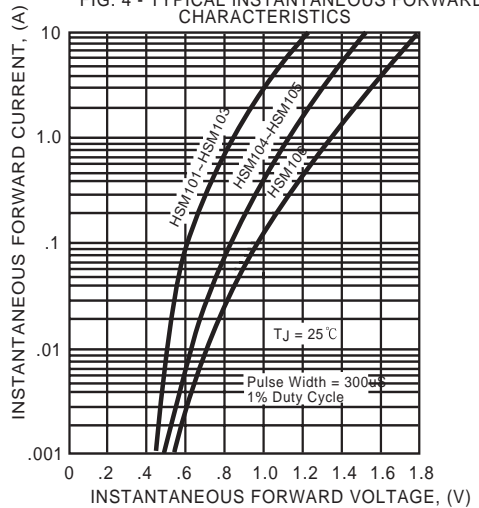

FIG. 5 - MAXIMUM NON-REPETITIVE FORWARD SURGE CURRENT

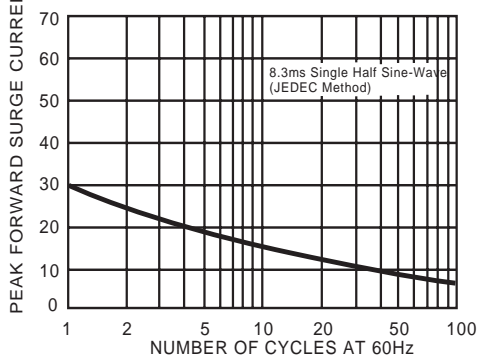

FIG. 6 - TYPICAL JUNCTION CAPACITANCE

